

AIR NOZZLES AND JETS

Superior designed Air Nozzle and Jets reduce compressed air consumption and noise levels while maintaining laminar flow for strong Blowoff

WHAT ARE THEY - REASONS TO USE

Air Nozzles are the smallest amplifiers for point applications.

Air Jets entrain large volumes of surrounding air through the Jet (similar to Air Amplifiers) and are more efficient than Air Nozzles. They cover a larger blowoff target than a Nozzle.

The larger the Nozzle or the Jet the greater the efficiency for flow amplification and significant energy savings can be achieved.

It is important to recognize that amplification Nozzles and Jets are “flow” amplifiers and not force amplifiers. However the more air consumed the greater the force produced.

The most important reason to use Air Nozzles or Jets is safety. All Nex Flow™ Air Nozzles and Jets meet OSHA standard CFR 1910.242(b) for dead end pressure. Noise levels are dramatically reduced with Air Nozzles and Jets in addition to lower energy use.



Nex Flow™ removes the confusion from Air Jets and Nozzles. You do NOT need hundreds of different nozzles. All air amplifying Nozzles produce air flows up to 25 times the compressed air consumed. Different Nozzles have different outlet sizes and the more air used, the greater the force produced. Noise reduction up to 10 dBA as well as reduced air consumption when compared to open Jets and Tubes.

By maintaining a reasonable choice of nozzles most valid applications can be addressed with our range.

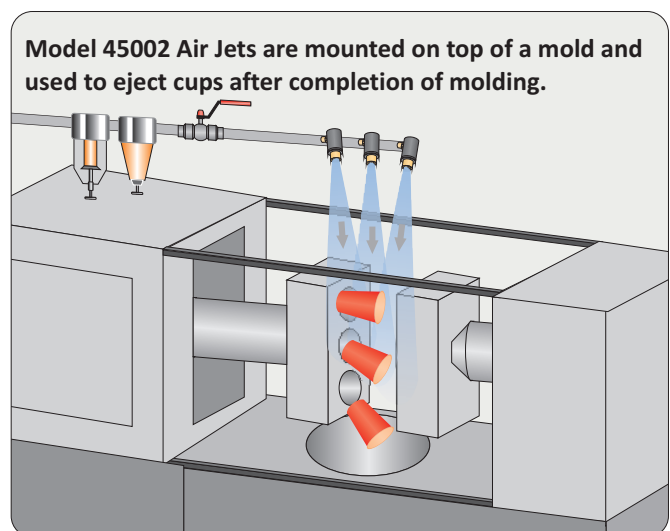
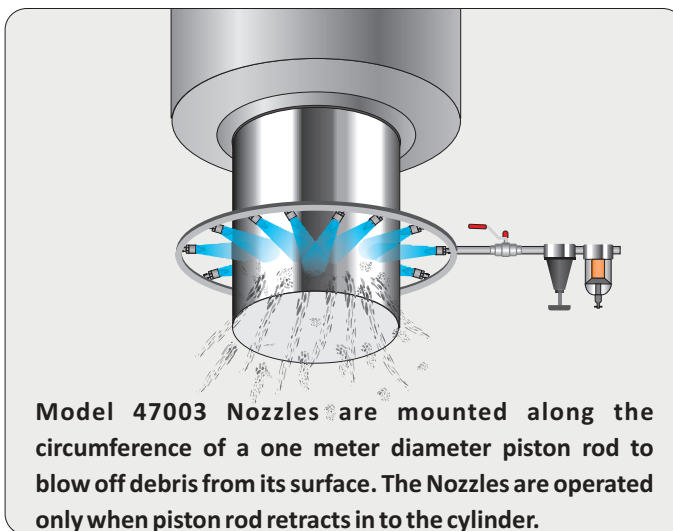

HOW IT WORKS

Air Nozzle - Models 47001, 47002, 47003, 47003S, 47003S-316L, 47004, 47004S, 47004S-316L, 47009, 47009S, 47009S-316L Compressed air enters at point (A). Surrounding air (B) is entrained over a specially designed profile surface by the action of the small amount of compressed air leaving the ring gap at point (C). This results in a concentrated high velocity, laminar flow stream of amplified air with maximized force.

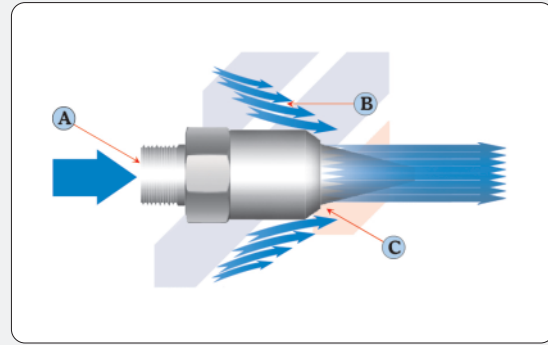

HOW IT WORKS

X-stream™ Air Nozzle - Model 47010 - Compressed air enters at point (A). Surrounding air (B) is entrained over a specially designed profile surface by the action of the small amount of compressed air leaving the small drilled holes at point (C). This results in a concentrated high velocity, laminar flow stream of amplified air with maximized force.

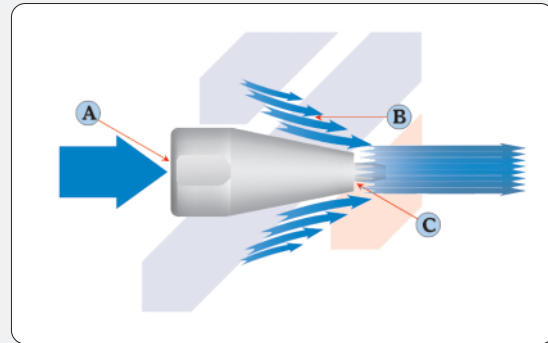

AIR NOZZLES

PART NO.	DESCRIPTION
47001	Brass Mini Nozzle with 10/32 fitting or metric equivalent
47002	Brass Mini Nozzle with copper tube - male
47003	Standard Aluminum 1/8" NPT male fitting
47003S	Standard 303/304 Stainless Steel 1/8" NPT male fitting
47003S-316L	Standard 316L Stainless Steel 1/8" NPT male fitting
47004	Extra Strong Aluminum 1/4" NPT male fitting
47004S	Standard 303/304 Stainless Steel 1/4" NPT male fitting
47004S-316L	Standard 316L Stainless Steel 1/4" NPT male fitting
47009	Adjustable Aluminum Nozzle with 1/8" male NPT fitting
47009S	Standard 303/304 Stainless Steel 1/8" NPT male fitting
47009S-316L	Standard 316L Stainless Steel 1/8" NPT male fitting
47010	X-Stream™ Anodized Aluminum Strong Force Nozzle with 1/4" female NPT fitting

STAINLESS STEEL RIGID FLEX HOSE (REFER TO PAGE M5 FOR THE RIGID FLEX HOSE)

PART NO.	DESCRIPTION
6RF (MM / MF)	6" Stainless Steel Rigid Hose which can be flexed to a shape
12RF (MM / MF)	12" Stainless Steel Rigid Hose which can be flexed to a shape
18RF (MM / MF)	18" Stainless Steel Rigid Hose which can be flexed to a shape

AIR NOZZLES:

Nex Flow™ Nozzles are designed to fit into small spaces. We have an adjustable Nozzle for some applications and then a few different Nozzles with varying force, depending on the application.



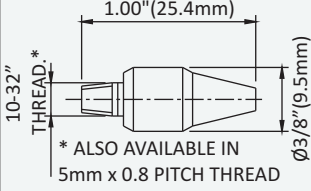

Model 47001 - Is a small brass Nozzle to fit into small spots and used by many machine builders for blowoff applications.

Sound level 74 dBA at 3ft (0.91mm) at 80 psig (5.6 bar).



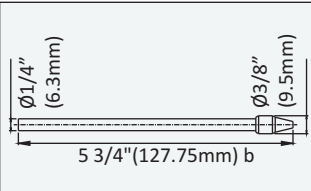

Model 47002 - Is the small Model 47001 brass Nozzle added to a copper tube. Machine builders can bend the copper tube and aim the nozzles to where ever it suits. The copper tube is simply press fit into the customer's system.

Sound level 74 dBA at 3ft (0.91mm) at 80 psig (5.6 bar).

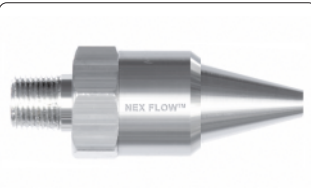

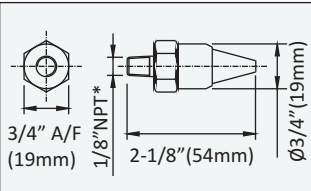

Model 47003 (anodized aluminum), 47003S (303/304 stainless steel), 47003S-316L (316L stainless steel) -

Is a common standard strength nozzle with a 1/8" male NPT connection and ideal for most blow-off applications involving liquids. It is made of aluminum (or stainless steel) and is partially anodized for longer life. The coanda profile is made for excellent noise reduction and blow-off force at a good distance

Sound level 77 dBA at 3ft (0.91mm) at 80 psig (5.6 bar).



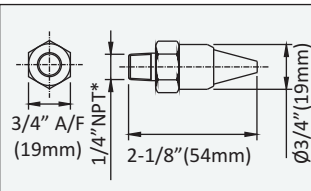

Model 47004 (anodized aluminum), 47004S (303/304 stainless steel), 47004S-316L (316L stainless steel) -

Is another common but stronger force nozzles with a 1/4" male NPT connection and ideal for most blow-off applications involving liquids and even light weight parts. It is made of aluminum (or stainless steel) and is partially anodized for longer life. Again the coanda profile is made for excellent noise reduction and blow-off force at a good distance.

Sound level 78 dBA at 3ft (0.91mm) at 80 psig (5.6 bar).



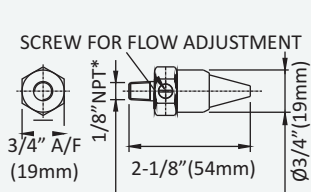

Model 47009 (anodized aluminum), 47009S (303/304 stainless steel), 47009S-316L (316L stainless steel) -

Is similar to the 47003 except it is made adjustable. The Superior design of the adjustable set screw is made to adjust the nozzles within its weakest and strongest ranges.



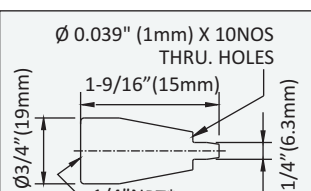

Model 47010 - Is a unique design by Nex Flow™ and is extremely powerful. It has a 1/4" female NPT fitting and is fully anodized for long life. With the 'coanda' profile you get an extremely strong force at a distance. This is an ideal Nozzle for blow guns and for blowing small parts for part ejection heavier viscosity liquids. The 47010 is a higher force Nozzle but has less distance for laminar flow than the 47004. Use the Model 47004 is greater distance required from the Nozzle.

Sound level 78 dBA at 3ft (0.91mm) at 80 psig (5.6 bar).

*BSP Threads or Adaptors can be supplied depending on country location.

Air Consumption At Various Pressure for Model 47001 and 47002 Air Nozzles

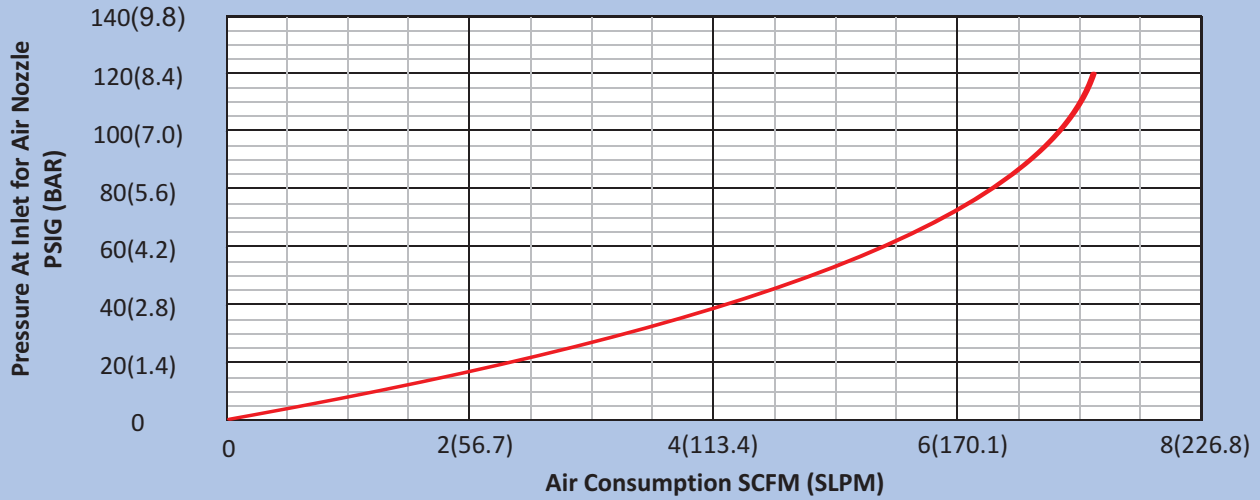

Force At Various Pressure for Model 47001 and 47002 Air Nozzles

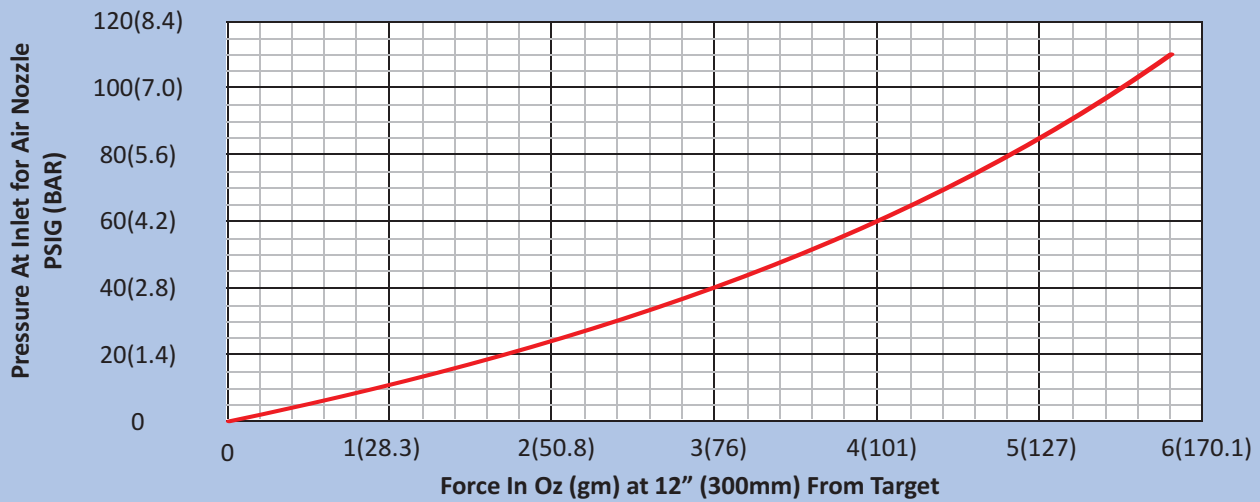

Air Consumption At Various Pressure for Model 47003, 47003S and 47003S-316L Air Nozzles.

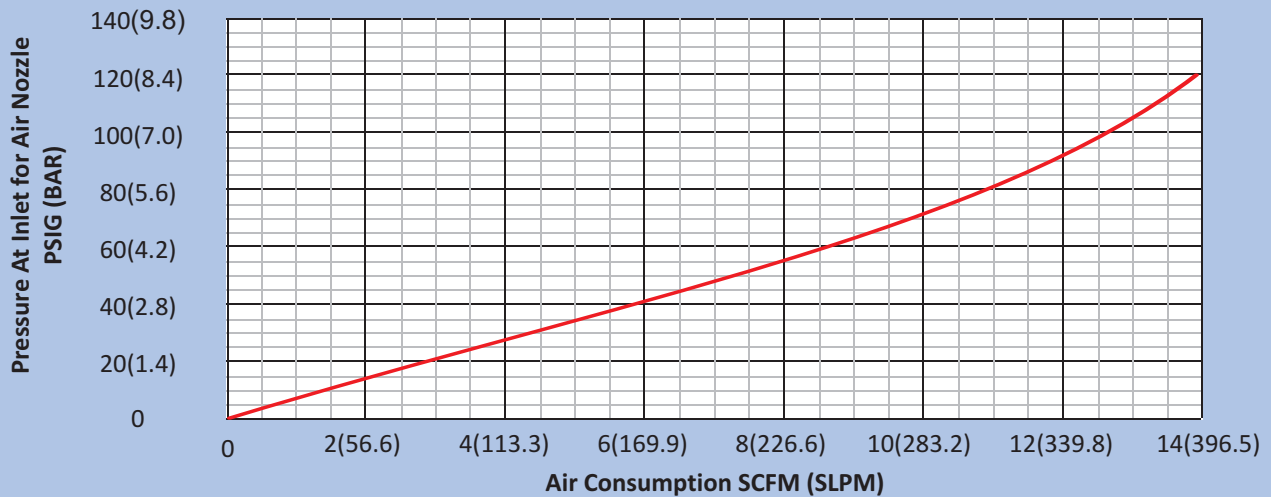

Force At Various Pressure for Model 47003, 47003S and 47003S-316L Air Nozzles.

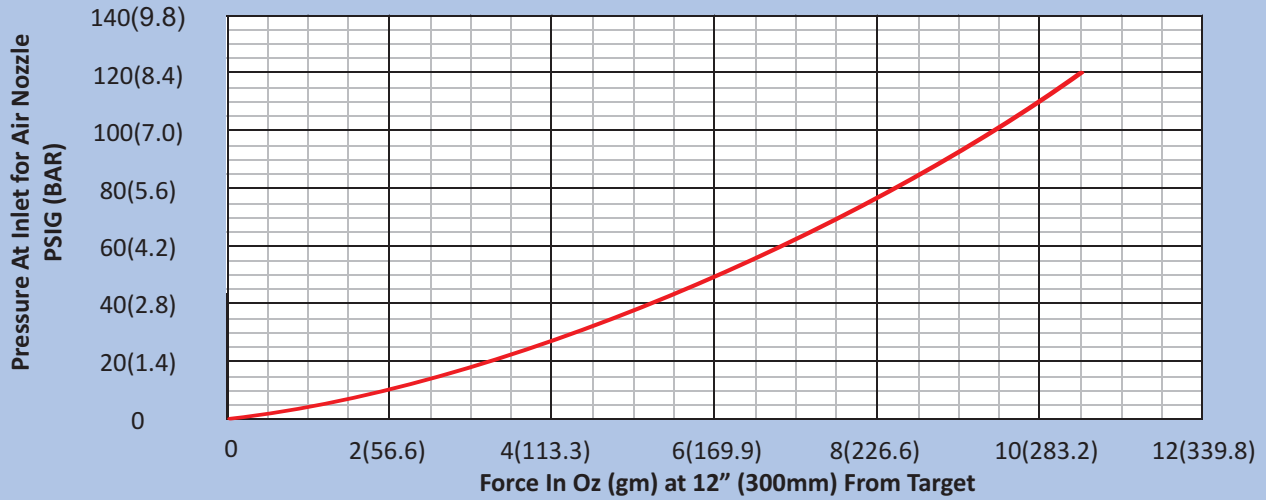

Air Consumption At Various Pressure for Model 47003, 47003S and 47003S-316L Air Nozzles.

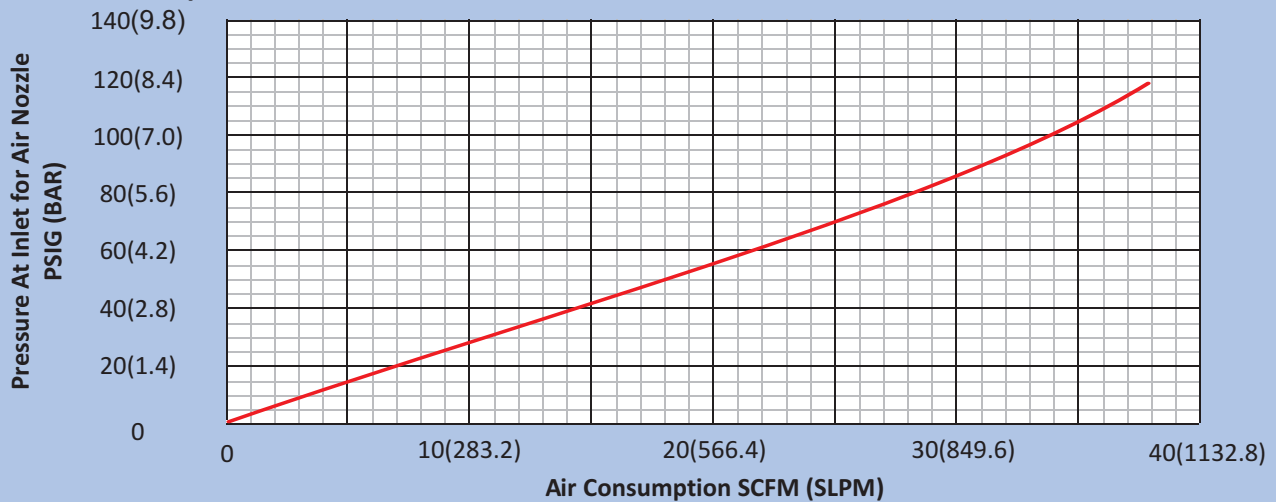

Force At Various Pressure for Model 47004, 47004S and 47004S-316L Air Nozzles.

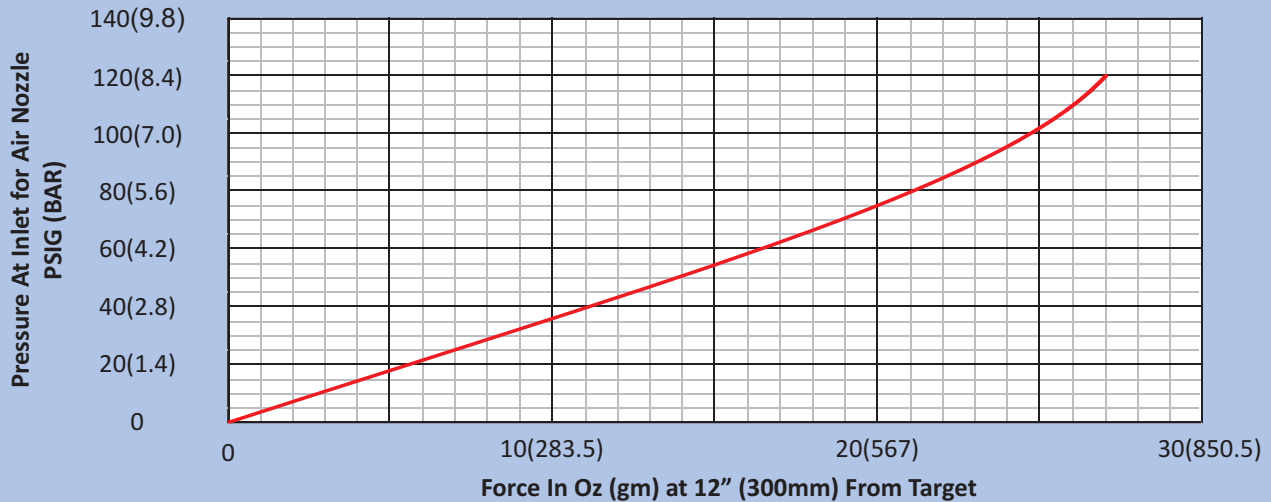

Air Consumption At Various Pressure for Model 47009, 47009S and 47009S-316L (Max Open condition)

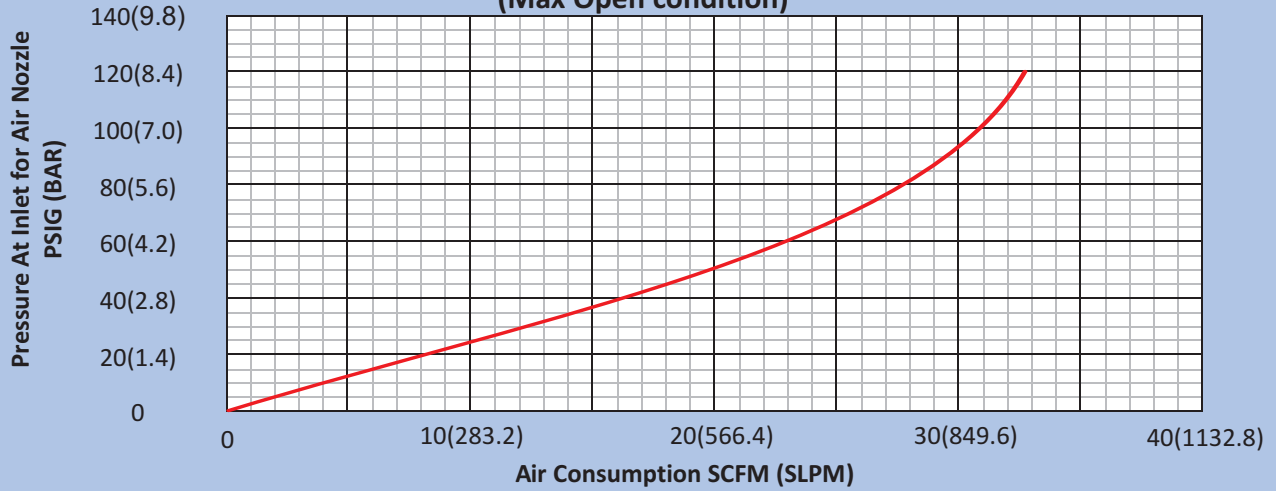

Force At Various Pressure for Model 47009, 47009S and 47009S-316L (Max Open condition)

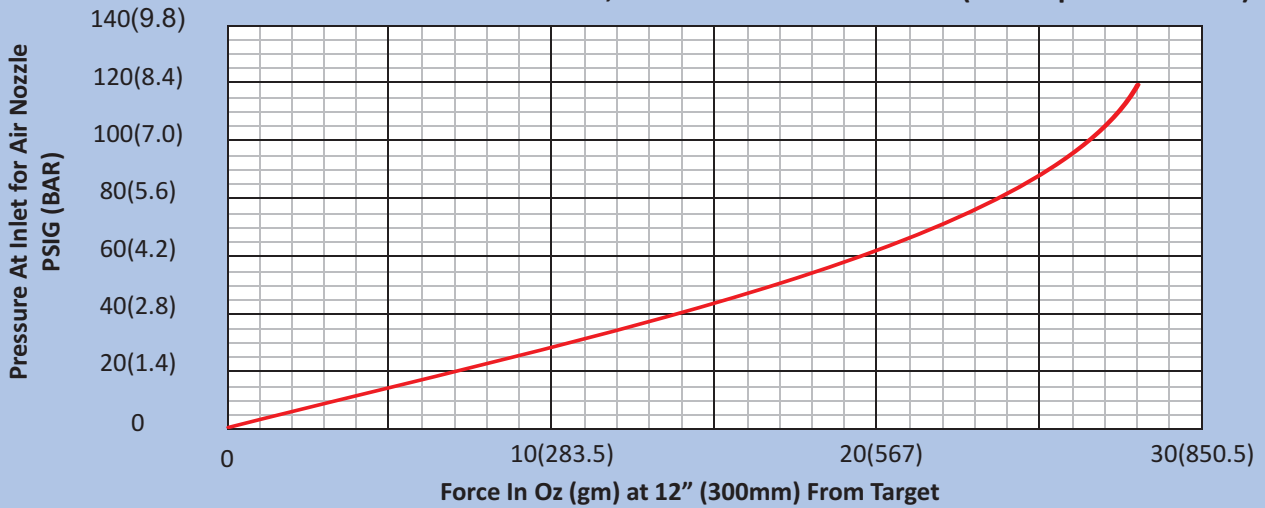

Air Consumption At Various Pressure for Model 47010 (10 Holes)

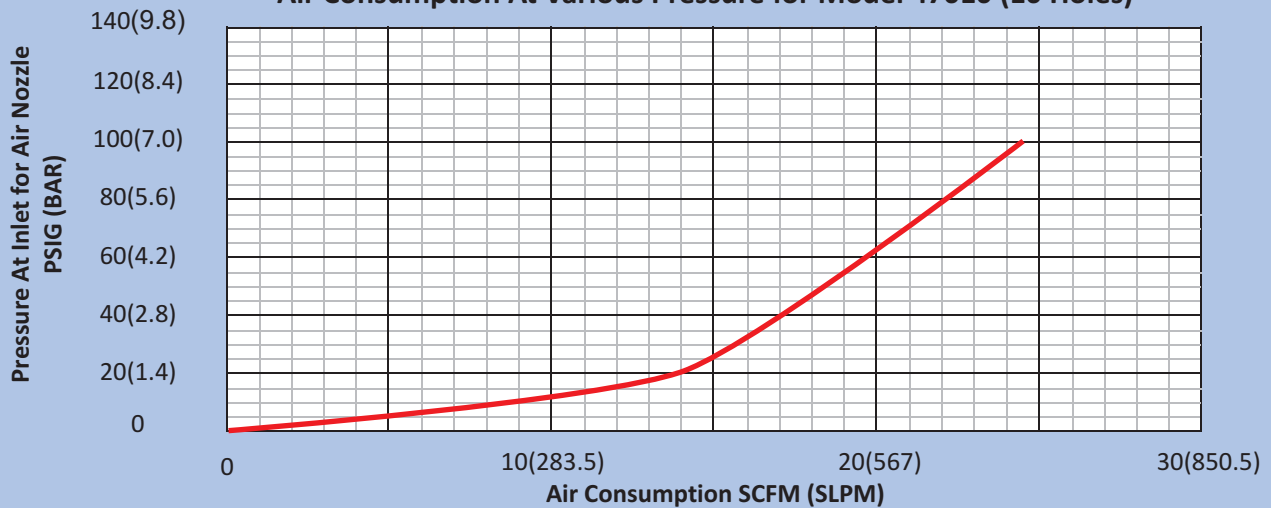

Force At Various Pressure for Model 47010 (10 Holes)

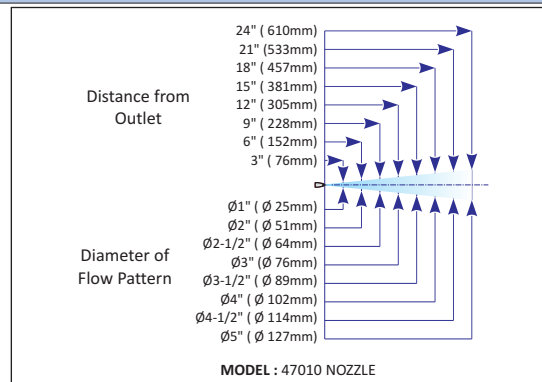
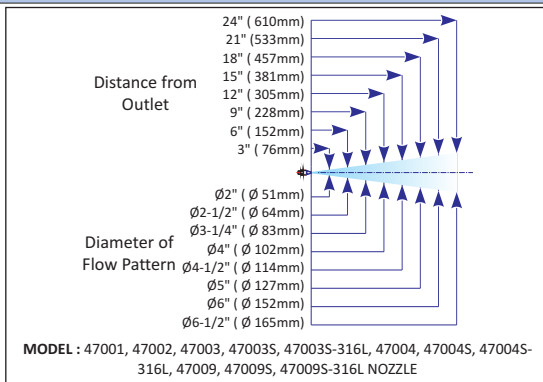
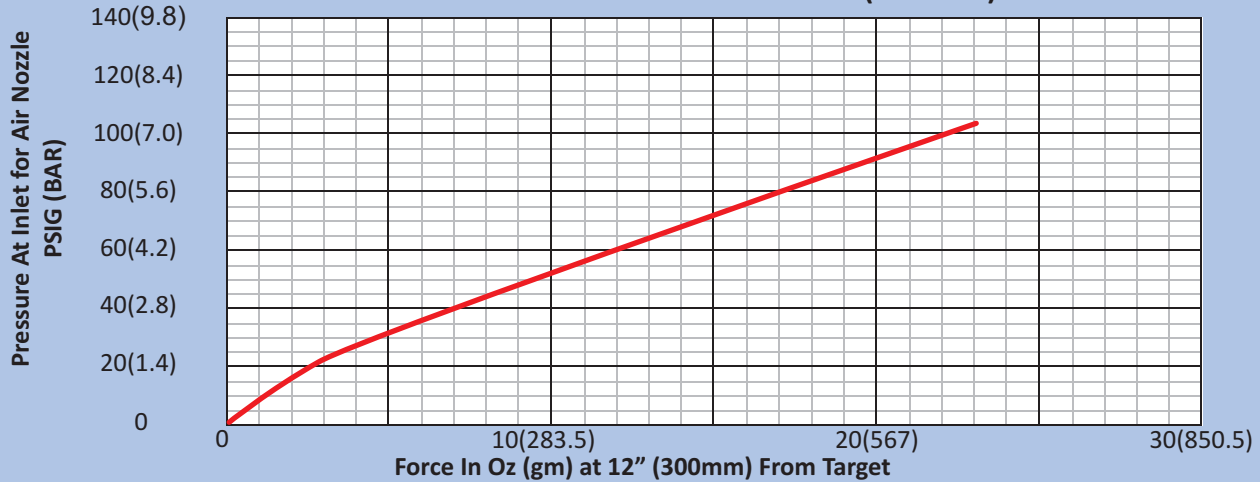

AIR NOZZLES

PART NO.	DESCRIPTION
47001	Brass Mini Nozzle with 10/32 fitting or metric equivalent
47002	Brass Mini Nozzle with copper tube - male
47003	Standard Aluminum 1/8" NPT male fitting
47003S	Standard 303/304 Stainless Steel 1/8" NPT male fitting
47003S-316L	Standard 316L Stainless Steel 1/8" NPT male fitting
47004	Extra Strong Aluminum 1/4" NPT male fitting
47004S	Standard 303/304 Stainless Steel 1/4" NPT male fitting
47004S-316L	Standard 316L Stainless Steel 1/4" NPT male fitting
47009	Adjustable Aluminum Nozzle with 1/8" male NPT fitting
47009S	Standard 303/304 Stainless Steel 1/8" NPT male fitting
47009S-316L	Standard 316L Stainless Steel 1/8" NPT male fitting
47010	X-Stream™ Anodized Aluminum Strong Force Nozzle with 1/4" female NPT fitting

STAINLESS STEEL RIGID FLEX HOSE (REFER TO PAGE E9 FOR THE RIGID FLEX HOSE)

PART NO.	DESCRIPTION
6RF (MM / MF)	6" Stainless Steel Rigid Hose which can be flexed to a shape
12RF (MM / MF)	12" Stainless Steel Rigid Hose which can be flexed to a shape
18RF (MM / MF)	18" Stainless Steel Rigid Hose which can be flexed to a shape